

NPN Silicon RF Transistor

- For highest gain low noise amplifier at 1.8 GHz and 2 mA / 2 V

Outstanding G_{ms} = 23.5 dB

Noise Figure F = 0.95 dB

- For oscillators up to 15 GHz
- Transition frequency $f_T = 45$ GHz
- Gold metallisation for high reliability
- **SIEGET® 45 - Line**
- Pb-free (RoHS compliant) package¹⁾
- Qualified according AEC Q101

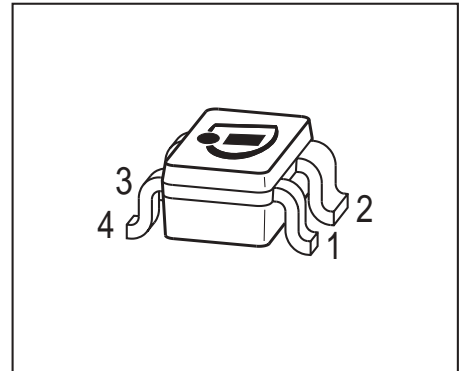

ESD (Electrostatic discharge) sensitive device, observe handling precaution!

Type	Marking	Pin Configuration						Package
BFP520	APs	1=B	2=E	3=C	4=E	-	-	SOT343

Maximum Ratings

Parameter	Symbol	Value	Unit
Collector-emitter voltage	V_{CEO}		V
$T_A > 0$ °C		2.5	
$T_A \leq 0$ °C		2.4	
Collector-emitter voltage	V_{CES}	10	
Collector-base voltage	V_{CBO}	10	
Emitter-base voltage	V_{EBO}	1	
Collector current	I_C	40	mA
Base current	I_B	4	
Total power dissipation ²⁾	P_{tot}	100	mW
$T_S \leq 105$ °C			
Junction temperature	T_j	150	°C
Ambient temperature	T_A	-65 ... 150	
Storage temperature	T_{stg}	-65 ... 150	

¹Pb-containing package may be available upon special request

² T_S is measured on the collector lead at the soldering point to pcb

Thermal Resistance

Parameter	Symbol	Value	Unit
Junction - soldering point ¹⁾	R_{thJS}	≤ 450	K/W

Electrical Characteristics at $T_A = 25^\circ\text{C}$, unless otherwise specified

Parameter	Symbol	Values			Unit
		min.	typ.	max.	

DC Characteristics

Collector-emitter breakdown voltage $I_C = 1 \text{ mA}, I_B = 0$	$V_{(BR)CEO}$	2.5	3	3.5	V
Collector-emitter cutoff current $V_{CE} = 10 \text{ V}, V_{BE} = 0$	I_{CES}	-	-	10	μA
Collector-base cutoff current $V_{CB} = 5 \text{ V}, I_E = 0$	I_{CBO}	-	-	200	nA
Emitter-base cutoff current $V_{EB} = 1 \text{ V}, I_C = 0$	I_{EBO}	-	-	35	μA
DC current gain $I_C = 20 \text{ mA}, V_{CE} = 2 \text{ V}$, pulse measured	h_{FE}	70	110	170	-

¹⁾For calculation of R_{thJA} please refer to Application Note Thermal Resistance

Electrical Characteristics at $T_A = 25^\circ\text{C}$, unless otherwise specified

Parameter	Symbol	Values			Unit
		min.	typ.	max.	
AC Characteristics (verified by random sampling)					
Transition frequency $I_C = 30\text{ mA}$, $V_{CE} = 2\text{ V}$, $f = 2\text{ GHz}$	f_T	32	45	-	GHz
Collector-base capacitance $V_{CB} = 2\text{ V}$, $f = 1\text{ MHz}$, $V_{BE} = 0$, emitter grounded	C_{cb}	-	0.06	0.13	pF
Collector emitter capacitance $V_{CE} = 2\text{ V}$, $f = 1\text{ MHz}$, $V_{BE} = 0$, base grounded	C_{ce}	-	0.3	-	
Emitter-base capacitance $V_{EB} = 0.5\text{ V}$, $f = 1\text{ MHz}$, $V_{CB} = 0$, collector grounded	C_{eb}	-	0.35	-	
Noise figure $I_C = 2\text{ mA}$, $V_{CE} = 2\text{ V}$, $Z_S = Z_{Sopt}$, $f = 1.8\text{ GHz}$	F	-	0.95	-	dB
Power gain, maximum stable ¹⁾ $I_C = 20\text{ mA}$, $V_{CE} = 2\text{ V}$, $Z_S = Z_{Sopt}$, $Z_L = Z_{Lopt}$, $f = 1.8\text{ GHz}$	G_{ms}	-	23.5	-	dB
Insertion power gain $V_{CE} = 2\text{ V}$, $I_C = 20\text{ mA}$, $f = 1.8\text{ GHz}$, $Z_S = Z_L = 50\ \Omega$	$ S_{21} ^2$	-	21	-	
Third order intercept point at output $V_{CE} = 2\text{ V}$, $I_C = 20\text{ mA}$, $f = 1.8\text{ GHz}$, $Z_S = Z_{Sopt}$, $Z_L = Z_{Lopt}$ $V_{CE} = 2\text{ V}$, $I_C = 7\text{ mA}$, $f = 1.8\text{ GHz}$, $Z_S = Z_{Sopt}$, $Z_L = Z_{Lopt}$	IP_3	-	25	-	dBm
		-	17	-	
1dB Compression point $I_C = 20\text{ mA}$, $V_{CE} = 2\text{ V}$, $Z_S = Z_{Sopt}$, $Z_L = Z_{Lopt}$, $f = 1.8\text{ GHz}$ $I_C = 7\text{ mA}$, $V_{CE} = 2\text{ V}$, $Z_S = Z_{Sopt}$, $Z_L = Z_{Lopt}$, $f = 1.8\text{ GHz}$	P_{-1dB}	-	12	-	
		-	5	-	

¹⁾ $G_{ms} = |S_{21} / S_{12}|$

SPICE Parameter (Gummel-Poon Model, Berkley-SPICE 2G.6 Syntax):
Transistor Chip Data:

IS =	15	aA	BF =	235	-	NF =	1	-
VAF =	25	V	IKF =	0.4	A	ISE =	25	fA
NE =	2	-	BR =	1.5	-	NR =	1	-
VAR =	2	V	IKR =	0.01	A	ISC =	20	fA
NC =	2	-	RB =	11	Ω	IRB =	-	A
RBM =	7.5	Ω	RE =	0.6	-	RC =	7.6	Ω
CJE =	235	fF	VJE =	0.958	V	MJE =	0.335	-
TF =	1.7	ps	XTF =	10	-	VTF =	5	V
ITF =	0.7	A	PTF =	50	deg	CJC =	93	fF
VJC =	0.661	V	MJC =	0.236	-	XCJC =	1	-
TR =	50	ns	CJS =	0	fF	VJS =	0.75	V
MJS =	0.333	-	XTB =	-0.25	-	EG =	1.11	eV
XTI =	0.35	-	FC =	0.5	-	TNOM	298	K

All parameters are ready to use, no scaling is necessary. Extracted on behalf of Infineon Technologies AG by: Institut für Mobil- und Satellitentechnik (IMST)

Package Equivalent Circuit:



L_{BI} =	0.47	nH
L_{BO} =	0.53	nH
L_{EI} =	0.23	nH
L_{EO} =	0.05	nH
L_{CI} =	0.56	nH
L_{CO} =	0.58	nH
C_{BE} =	136	fF
C_{CB} =	6.9	fF
C_{CE} =	134	fF

Valid up to 6GHz

The SOT343 package has two emitter leads. To avoid high complexity to the package equivalent circuit both leads are combined in one electrical connection

For examples and ready to use parameters please contact your local Infineon Technologies distributor or sales office to obtain a Infineon Technologies CD-ROM or see Internet: <http://www.infineon.com/silicondiscretes>

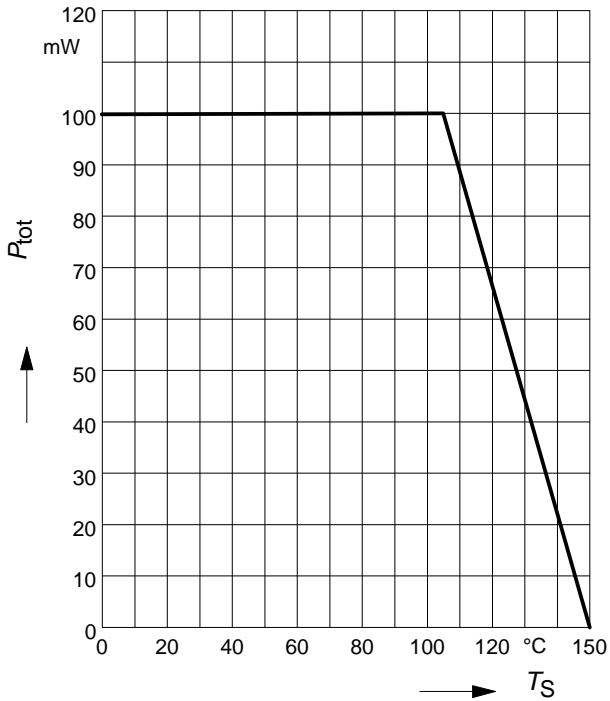
Total power dissipation $P_{tot} = f(T_S)$



Permissible Pulse Load $R_{thJS} = f(t_p)$

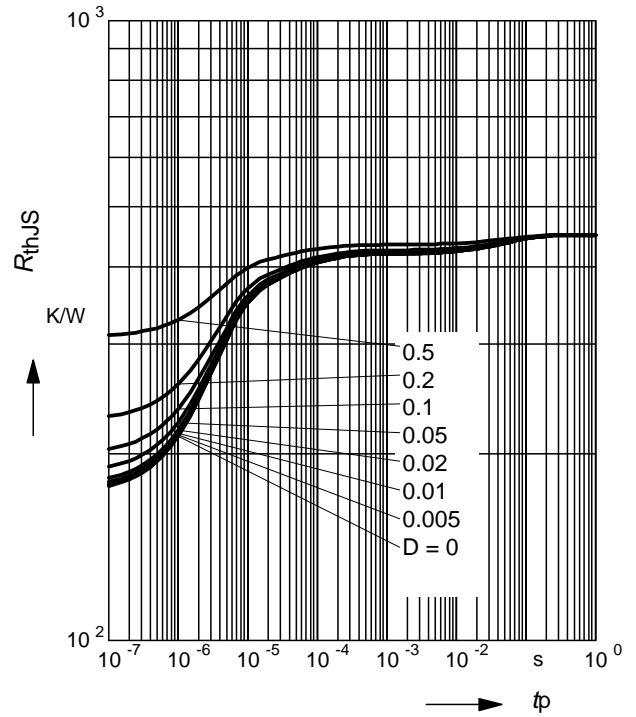

Permissible Pulse Load

$P_{totmax}/P_{totDC} = f(t_p)$

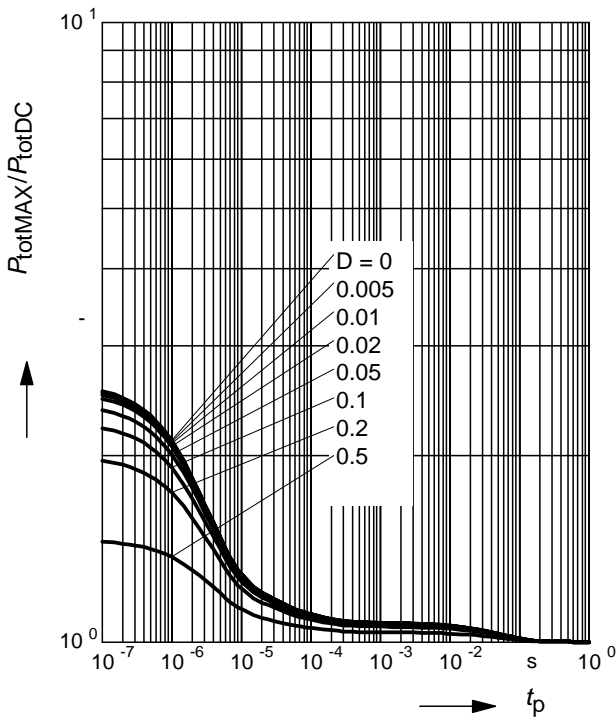

Collector-base capacitance $C_{cb} = f(V_{CB})$

$f = 1\text{MHz}$

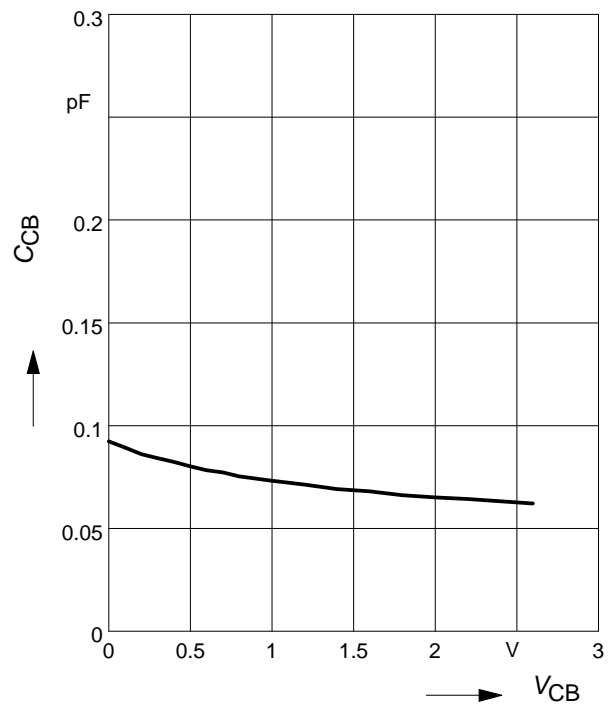

Transition frequency $f_T = f(I_C)$

$f = 2 \text{ GHz}$

$V_{CE} = \text{parameter in V}$

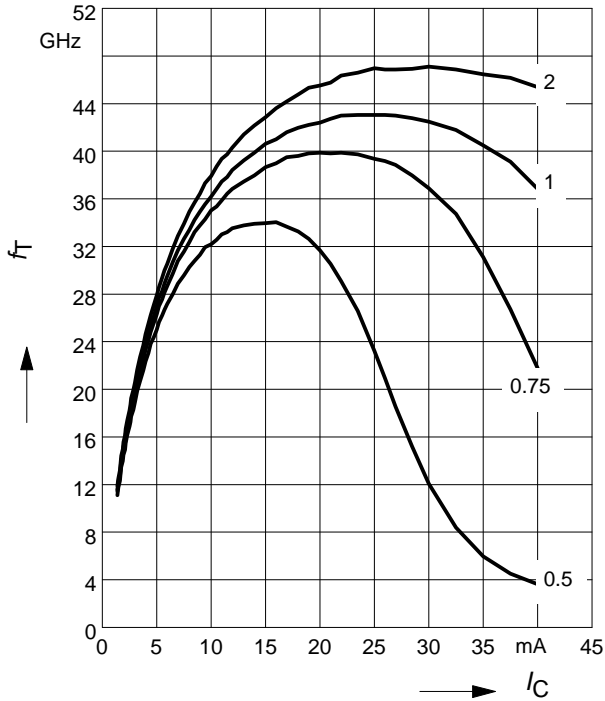

Power gain $G_{ma}, G_{ms}, |S_{21}|^2 = f(f)$

$V_{CE} = 2 \text{ V}, I_C = 20 \text{ mA}$

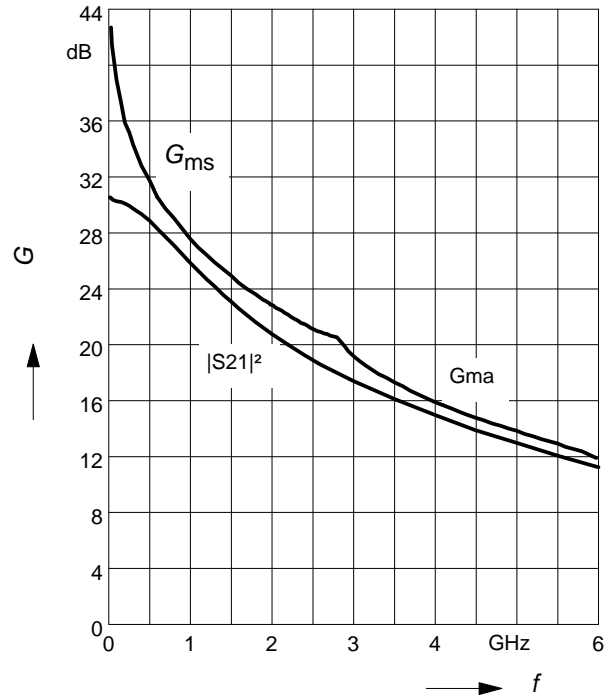

Power gain $G_{ma}, G_{ms} = f(I_C)$

$V_{CE} = 2 \text{ V}$

$f = \text{parameter in GHz}$

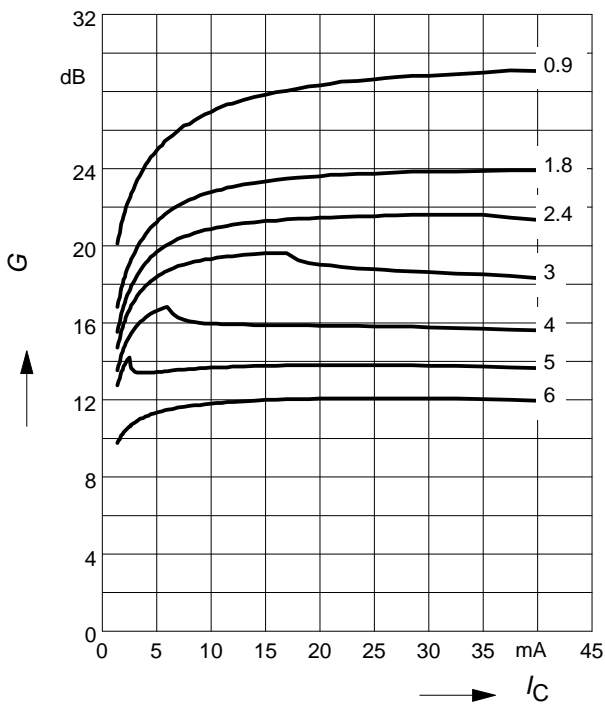

Power gain $G_{ma}, G_{ms} = f(V_{CE})$

$I_C = 20 \text{ mA}$

$f = \text{parameter in GHz}$

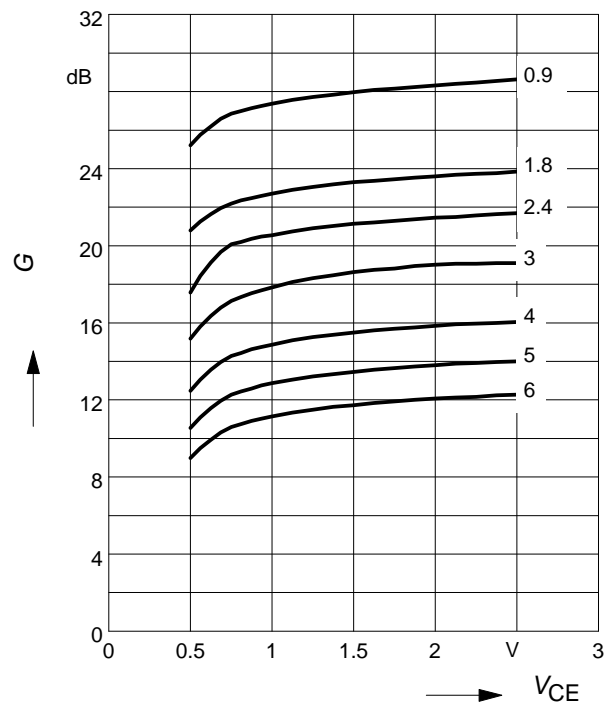

Noise figure $F = f(I_C)$

$V_{CE} = 2\text{ V}$, $Z_S = Z_{Sopt}$

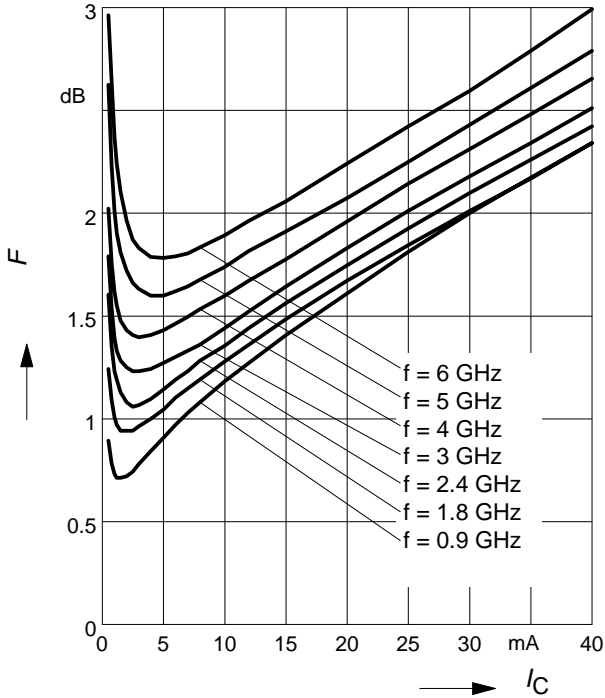

Noise figure $F = f(I_C)$

$V_{CE} = 2\text{ V}$, $f = 1.8\text{ GHz}$

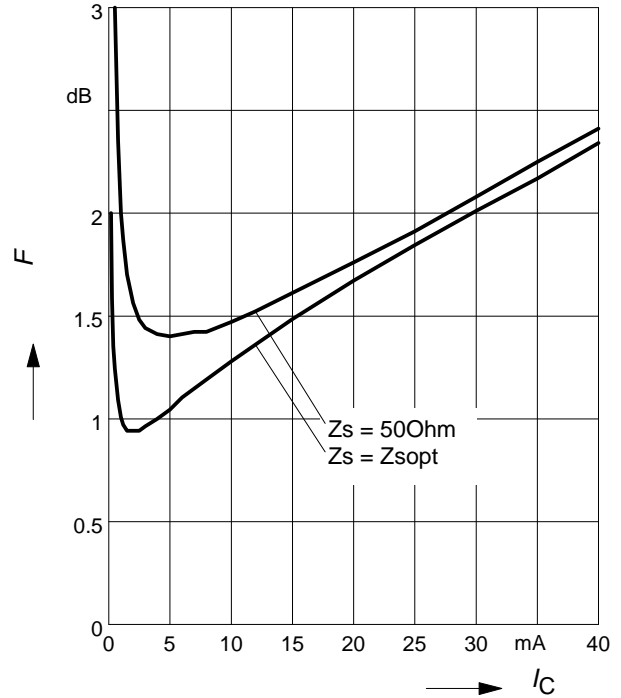

Noise figure $F = f(f)$

$V_{CE} = 2\text{ V}$, $Z_S = Z_{Sopt}$

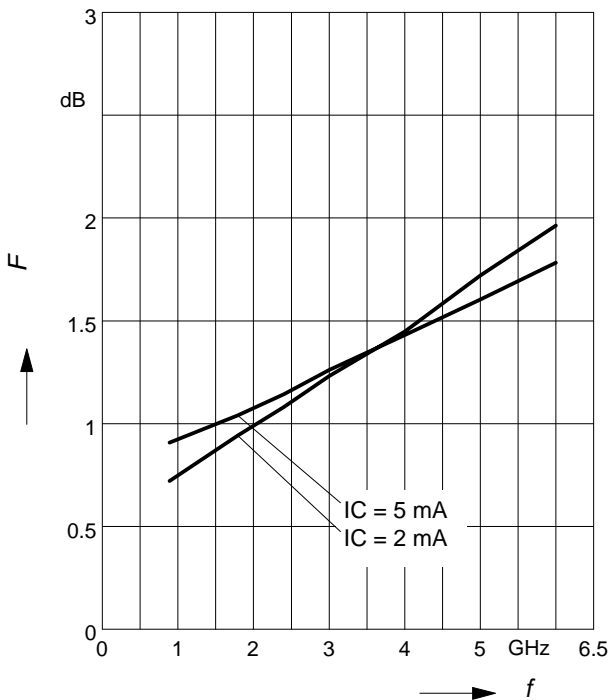

Source impedance for min.

noise figure vs. frequency

$V_{CE} = 2\text{ V}$, $I_C = 2\text{ mA} / 5\text{ mA}$

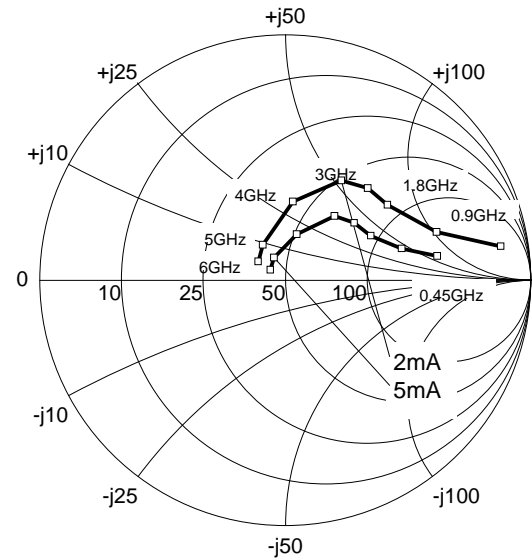

Package Outline

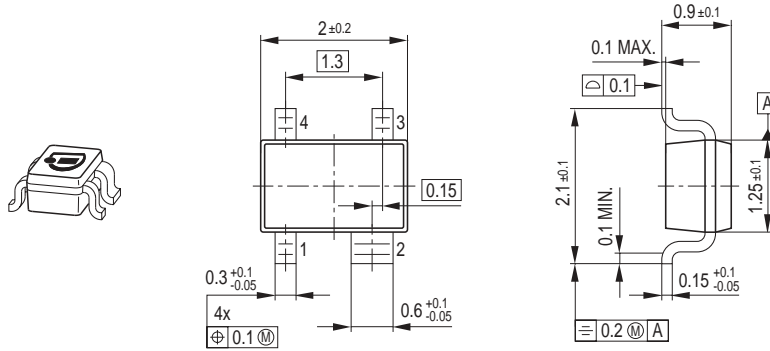

Foot Print

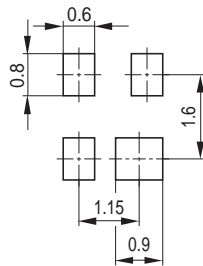

Marking Layout (Example)

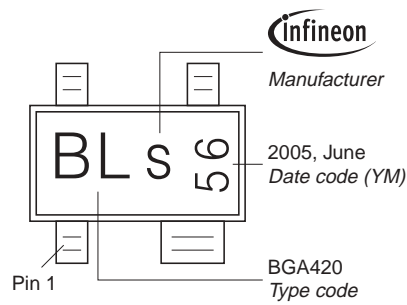

Standard Packing

Reel ø180 mm = 3.000 Pieces/Reel
 Reel ø330 mm = 10.000 Pieces/Reel

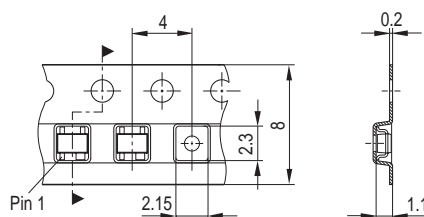

Edition 2006-02-01

Published by

Infineon Technologies AG

81726 München, Germany

© Infineon Technologies AG 2007.

All Rights Reserved.

Attention please!

The information given in this dokument shall in no event be regarded as a guarantee of conditions or characteristics ("Beschaffenheitsgarantie"). With respect to any examples or hints given herein, any typical values stated herein and/or any information regarding the application of the device, Infineon Technologies hereby disclaims any and all warranties and liabilities of any kind, including without limitation warranties of non-infringement of intellectual property rights of any third party.

Information

For further information on technology, delivery terms and conditions and prices please contact your nearest Infineon Technologies Office (www.infineon.com).

Warnings

Due to technical requirements components may contain dangerous substances. For information on the types in question please contact your nearest Infineon Technologies Office.

Infineon Technologies Components may only be used in life-support devices or systems with the express written approval of Infineon Technologies, if a failure of such components can reasonably be expected to cause the failure of that life-support device or system, or to affect the safety or effectiveness of that device or system.

Life support devices or systems are intended to be implanted in the human body, or to support and/or maintain and sustain and/or protect human life. If they fail, it is reasonable to assume that the health of the user or other persons may be endangered.